

**Z-SERIES SQUARE TYPE
RADIUS BASE ZINC CLAMPS
FOR 1/2" GLASS
CAT NO. Z612XX**

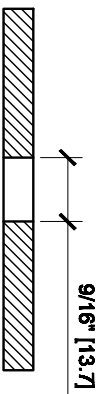
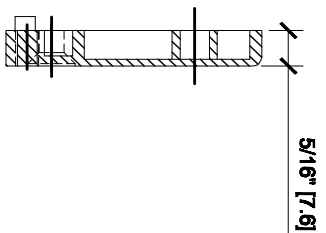
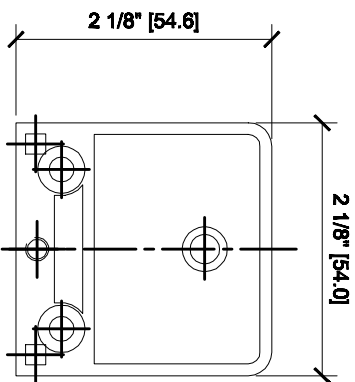
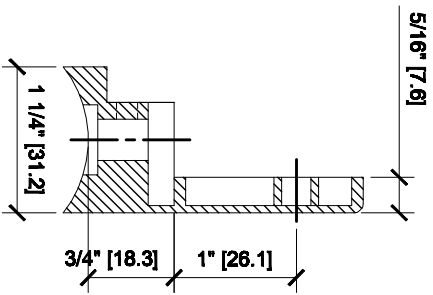
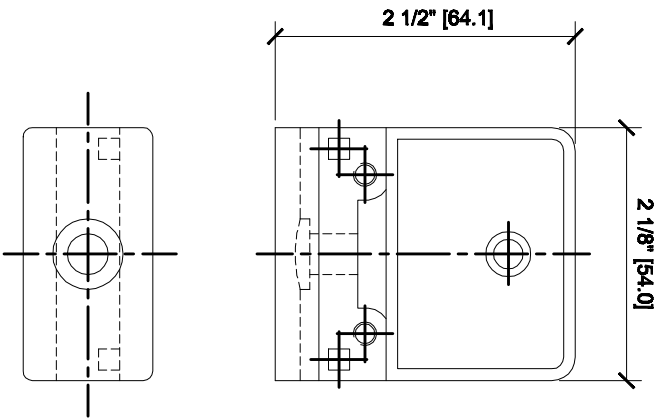

GLASS FABRICATION